

















HERRAJES Y COMPLEMENTOS PARA MUEBLES



FERRETERIA COLLBLANCH. S.L.



	ESCURRES ACERO INOXIDABLE (juego completo)	3		MECANISMO ELEVABLE	16
	CESTO MULTIUSO	3		SOPORTE ESTANTERIA	16
	RINCONERO EXTRAÍBLE 270°	4		PELICANOS	16
	RINCONERO EXTRAÍBLE con freno	4		JUEGO COLGADOR OCULTO	16
	RINCONERO EXTRAÍBLE REVERSIBLE	4		TIRA DE LEDS	17
	RINCONERO EXTRAÍBLE "RIÑÓN" con freno	5		TORRE	17
	BOTELLERO	5		TORNILLOS	18
	CESTO MULTIUSOS 2 niveles	5		TORNILLO ENSAMBLAJE	18
	JUEGO BANDEJAS SEMICIRCULARES 180°	6		LÁGRIMAS	18
	JUEGO BANDEJAS GIRATORIAS 270°	6		TAPONES ADHESIVOS	18
	PERSIANA ALUMINIO	6		TUBO OVALADO	19
	CAJÓN COSMOS	7		PANTALONERO Extraíble y extensible	19
	CAJÓN METÁLICO	8		PANTALONERO Extraíble	19
	GUÍAS OCULTAS 3D Extracción total con freno	9		SOPORTE CENTRAL Y LATERAL	19
	GUÍAS OCULTAS 3D Extracción total con push	9		PLANCHA PLEGABLE	20
	GUÍAS DE BOLAS	9		COLGADOR 3 posiciones	20
	GUÍAS METÁLICAS	9		COLGADOR ABATIBLE	20
	PATAS DE MESA	10		COLGADOR EXTRAÍBLE	20
	PATAS DECORATIVAS	10		ZAPATERO Extensible-extraíble con frontal	21
	CONTENEDORES ECOLÓGICOS	11		ZAPATERO Extensible	21
	CUBO ENCASTRAR ENCIMERA	11		PANTALONERO 9 o 11 perchas	21
	SET CONTENEDORES ECOLÓGICOS	12		PANTALONERO 20 perchas	21
	CUBO ECOLÓGICO 11l	13		PANTALONERO Varillas	22
	CONTENEDORES ECOLÓGICOS	13		CESTO	22
	BISAGRAS CLIP-ON 110° con freno	14		COLGADOR	22
	BISAGRAS CLIP-ON 110°	14		PANTALONERO Varillas con cesto	22
	BISAGRAS CLIP-ON 30° / 45° / 90° con freno	14		ZAPATERO	22
	BISAGRAS CLIP-ON 165° con freno	14		PANTALONERO LATERAL	22
	BASES CLIP-ON	15		FREGADERO INOX Bajo encimera	23
	PISTONES	15		FREGADERO INOX Encastrable	25
	EMBELLECEDORES	15		DISPENSADOR DE JABÓN	28
				MANILLAS ALUMINIO	29
				MANILLAS INOX	29
				BOCALLAVES Y MULETILLAS	29
				MANILLAS PLACA	29
				MANILLONES	30
				PICAPORTE UNIFICADO	30
				PERNIOS	30
				BISAGRA SEGURIDAD	30



ESCURRES ACERO INOXIDABLE

El juego incluye: escurreplatos, escurrevasos y bandeja recogeaguas. Fijación mediante pivote expansor con muelle, para taladro de Ø10.

Módulo	Acero Inox	Acero Inox Negro	
400	NNX1		5
450	NX2		5
500	NX3		5
600	NX4	NX4NE	5
700	NX5		5
800	NX6	NX6NE	5
900	NX7	NX7NE	5
1000	NX8		5

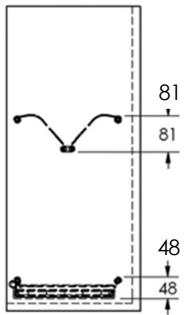

CESTO MULTIUSO



Código	Módulo	Medidas	
NX30	300	198 x 460 x 140	1
NX35	350	248 x 460 x 140	1
NX40	400	298 x 460 x 140	1
NX45	450	348 x 460 x 140	1
NX50	500	398 x 460 x 140	1
NX60	600	498 x 460 x 140	1
NX70	700	598 x 460 x 140	1
NX80	800	698 x 460 x 140	1
NX90	900	798 x 460 x 140	1

Todas las guías se adaptan a laterales de 16 a 19 mm

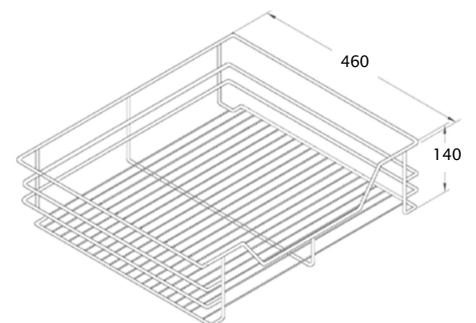

Código	Tipo	
AS	Bolas sin freno	1
AC	Cuadro con freno	1





RINCONERO EXTRAÍBLE 270°



Código	Módulo	
NX15	900	1

- Compuesto de 12 cestas
- Cada cesta soporta 4kg.
- Altura ajustable (650-750)

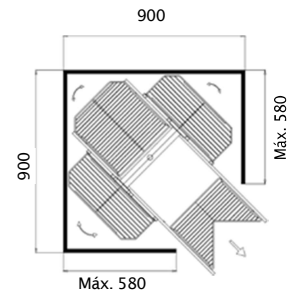

RINCONERO EXTRAÍBLE con freno

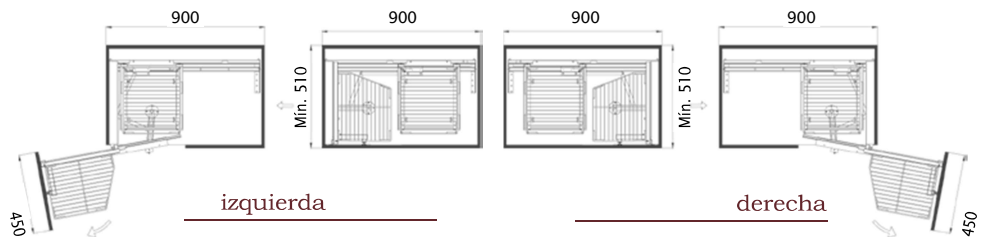

Código	Módulo	Apertura	
NX11	900	Izquierda	1
NX12	900	Derecha	1

- Cada cesta soporta 6kg.
- Con cierre suave
- Altura ajustable (620-750)

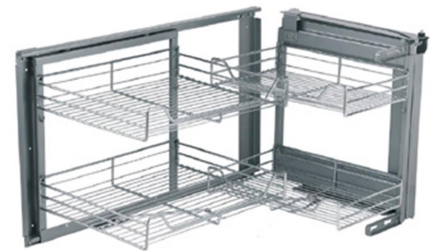

RINCONERO EXTRAÍBLE REVERSIBLE



Código	Módulo	
NX10	800	1
NX10F (con freno)	800	1
NX10 ANT	800	1

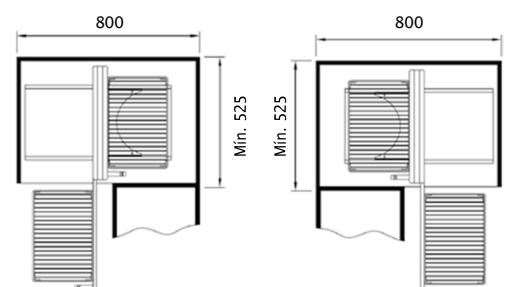

- Es reversible, puede instalarse para movimiento derecho o movimiento izquierdo, indistintamente.
- Válido para puerta de 400 o 450mm
- Cada cesta soporta 5kg.



RINCONERO EXTRAÍBLE "RIÑÓN" con freno



Código	Módulo	Apertura	Acabado	
NX13	900	Izquierda	Gris	1
NX14	900	Derecha	Gris	1
NX13BL	900	Izquierda	Blanco	1
NX14BL	900	Derecha	Blanco	1

izquierda

derecha

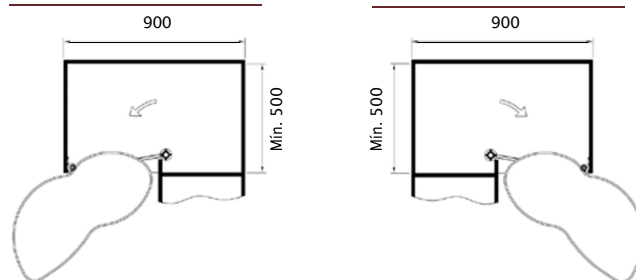

- Base con esterilla antideslizante

BOTELLERO



Código	Mueble	Tipo	
BC15G1	150	Derecha	1
BC15G2	150	Izquierda	1
BC20G1	200	Derecha	1
BC20G2	200	Izquierda	1

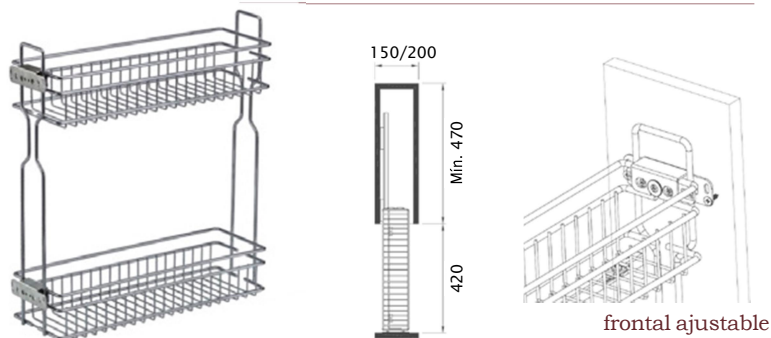

- Ejemplo de montaje con guía derecha
- Con guías de extracción total cuadro de cierre suave

CESTO MULTIUSOS 2 niveles

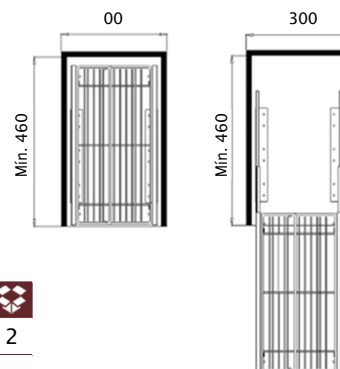

Código	Módulo	
NX28	300	2



JUEGO BANDEJAS SEMICIRCULARES 180°



Código	Módulo	
NX16	800	1

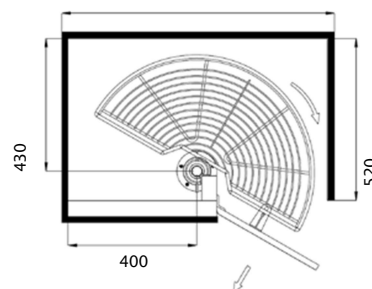

JUEGO BANDEJAS GIRATORIAS 270°

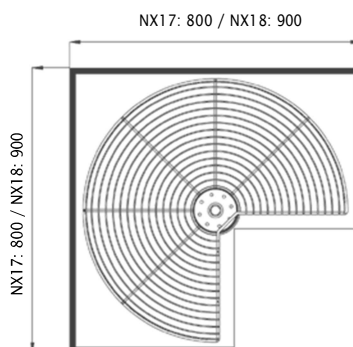
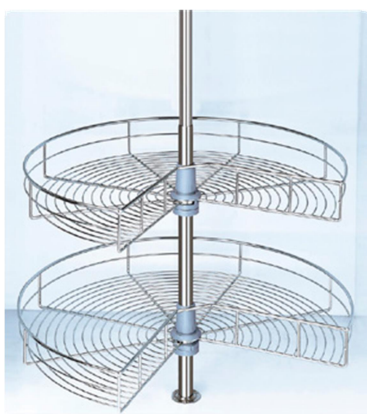

Código	Módulo	
NX17	800	1
NX18	900	1

PERSIANA ALUMINIO



- Tensión del muelle ajustable
- Se adapta a laterales de 16, 18 y 19
- Lamas de 25 mm
- Consultar para lamas de 50 mm

Código	Medida	Acabado	
SB600x1470	600 x 1470	Plata mate	1
SB600x1200	600 x 1200	Plata mate	1
SB600x900	600 x 900	Plata mate	1
SB900x1470	900 x 1470	Plata mate	1
SB450x1470	450 x 1470	Plata mate	1
SB600x1470BL	600 x 1470	Blanco	1
SB600x1200BL	600 x 1200	Blanco	1
SB600x900BL	600 x 900	Blanco	1
SB900x1470BL	900 x 1470	Blanco	1
SB450x1470BL	450 x 1470	Blanco	1



RINCONERO EXTRAÍBLE "RIÑÓN" Grafito



- Esterilla antideslizante incluida
- Cierre suave

Código	Módulo	Apertura
KM13	90	IZQUIERDA
KM14	90	DERECHA

BOTELLERO Grafito

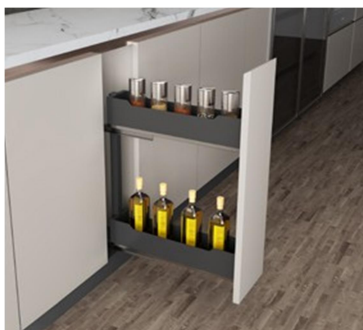

- Esterilla antideslizante incluida
- Cierre suave

Código	Módulo	Embalaje
KM15	15	1
KM20	20	1
KM25	25	1
KM30	30	1

RINCONERO EXTRAÍBLE Grafito



- Modelo reversible (apertura a izquierda o derecha)
- Esterilla antideslizante incluida
- Cierre suave

Código	Módulo	Embalaje
KM10	90	1

RINCONERO EXTRAÍBLE ARTICULADO Grafito



- Modelo reversible (apertura a izquierda o derecha)
- Esterilla antideslizante incluida
- Cierre suave

Código	Módulo	Embalaje
KM11	90	1



CUBERTERO



RA17CUBAN40



RA17CUBAN50

- Cubertero de fondo 473 y altura 50
- Para tablero de 16

Código Antracita	Código Blanco	Módulo	Ancho	
RA17CUBAN40	RA17CUBW40	40	327	25
RA17CUBAN45	RA17CUBW45	45	377	25
RA17CUBAN50	RA17CUBW50	50	427	25
RA17CUBAN60	RA17CUBW60	60	527	25
RA17CUBAN70	RA17CUBW70	70	627	20
RA17CUBAN80	RA17CUBW80	80	727	20
RA17CUBAN90	RA17CUBW90	90	827	20

CUBERTERO EXTENSIBLE



Código Claro	Código Oscuro	Ancho extensible	
BLC305	BLO305	305 a 525	5
BLC505	BLO505	505 a 825	5
BLC705	BLO705	705 a 1020	5

- Cubertero de fondo 473
- Para tablero de 16



SALVASIFÓN (para cajón Fine)

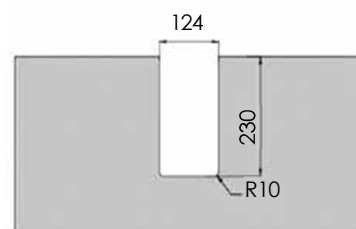

Código Antracita	Código Blanco	Módulo	
RA17US80	RA17US80BL	80	60
RA17US120	RA17US120BL	120	60



CAJÓN METÁLICO



Altura 86

Altura 118

Altura 150

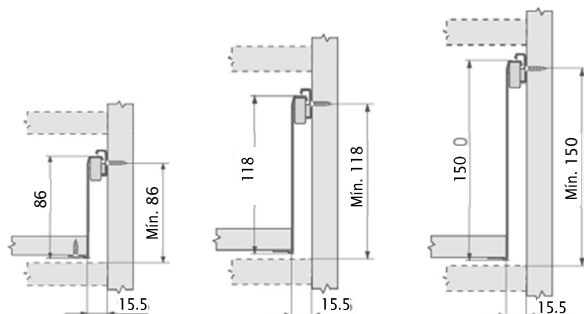

Código	Fondo	Altura	Acabado	
RA12-2786 B	270	86	Blanco	10
RA12-3086 B	300	86	Blanco	10
RA12-3586 B	350	86	Blanco	10
RA12-4086 B	400	86	Blanco	10
RA12-4586 B	450	86	Blanco	10
RA12-5086 B	500	86	Blanco	10
RA12-2786 G	270	86	Gris	10
RA12-3086 G	300	86	Gris	10
RA12-3586 G	350	86	Gris	10
RA12-4086 G	400	86	Gris	10
RA12-4586 G	450	86	Gris	10
RA12-5086 G	500	86	Gris	10
RA12-3011 B	300	118	Blanco	10
RA12-3511 B	350	118	Blanco	10
RA12-4011 B	400	118	Blanco	10
RA12-4511 B	450	118	Blanco	10
RA12-5011 B	500	118	Blanco	10
RA12-3011 G	300	118	Gris	10
RA12-3511 G	350	118	Gris	10
RA12-4011 G	400	118	Gris	10
RA12-4511 G	450	118	Gris	10
RA12-5011 G	500	118	Gris	10
RA12-3015 B	300	150	Blanco	10
RA12-3515 B	350	150	Blanco	10
RA12-4015 B	400	150	Blanco	10
RA12-4515 B	450	150	Blanco	10
RA12-5015 B	500	150	Blanco	10
RA12-3015 G	300	150	Gris	10
RA12-3515 G	350	150	Gris	10
RA12-4015 G	400	150	Gris	10
RA12-4515 G	450	150	Gris	10
RA12-5015 G	500	150	Gris	10



GUÍAS OCULTAS 3D

Guías sincronizadas de extracción total y cierre suave
Capacidas de carga 30 kg



Lateral de cajón máx. 16

Código Cierre suave	Código Push	Módulo	
RA1627	RA1527	270	10
RA1630	RA1530	300	10
RA1635	RA1535	350	10
RA1640	RA1540	400	10
RA1645	RA1545	450	10
RA1650	RA1550	500	10
RA1655	RA1555	550	10

Lateral de cajón máx. 19

Código Cierre suave	Módulo	
RA1027	270	10
RA1030	300	10
RA1035	350	10
RA1040	400	10
RA1045	450	10
RA1050	500	10
RA1055	550	10

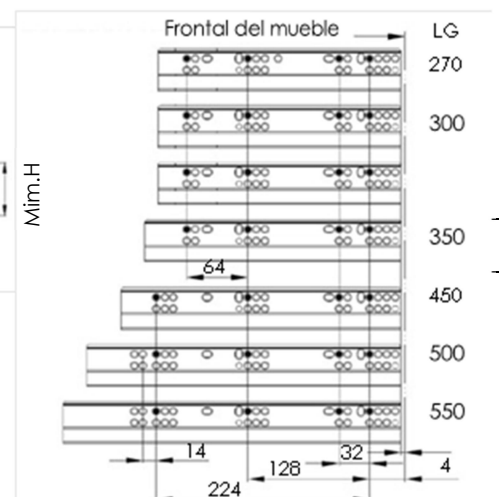
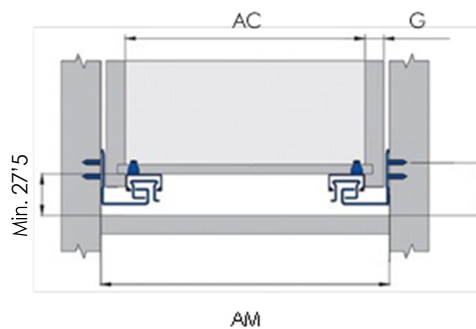
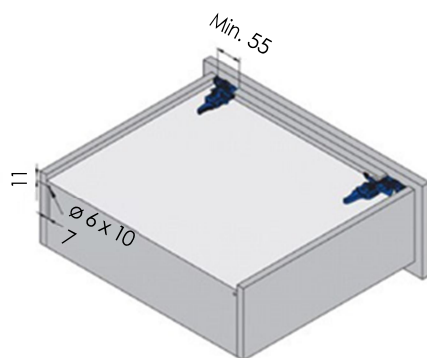

LG = Longitud de la guía
LC = Longitud del cajón
AC = Ancho cajón
AM = Ancho mueble
G = Grosor lateral del cajón

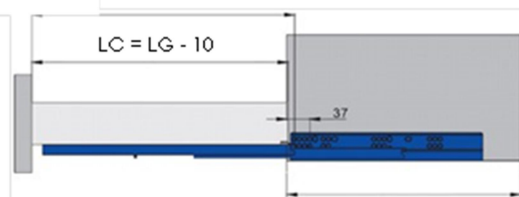

Longitud mínima del mueble = LG + 5

G	AC	Ejemplo	H
16 =	AM - 42	AM = 564 Y AC = 522 ≈ 523,5	10
19 =	AM - 48	AM = 564 Y AC = 516 ≈ 517,5	10



CONTENEDORES ECOLÓGICOS



- Con guías de extracción total que soportan hasta 30kg.
- El contenedor se fija en la base del mueble

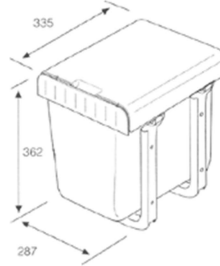
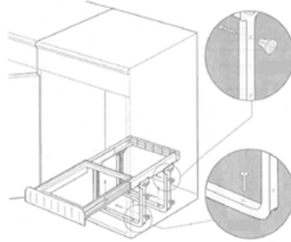

Código	Capacidad	
CB116	16l. (1x16l.)	1



- Con guías de extracción total que soportan hasta 50kg.
- El contenedor se fija en la base del mueble

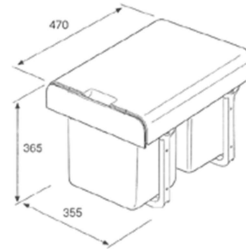
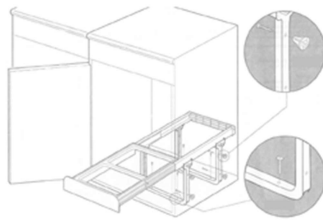

Código	Capacidad	
CB216	32l. (2x16l.)	1



- Con guías de extracción total que soportan hasta 50kg.
- El contenedor se fija en la base y en la puerta del mueble

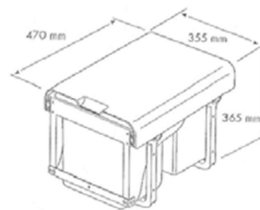
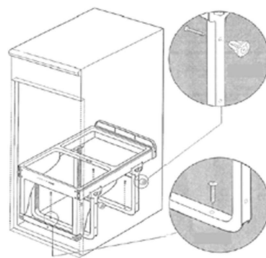

Código	Capacidad	
CB316	32l. (2x16l.)	1

CUBO ENCASTRAR ENCIMERA



- Acabado acero inoxidable
- Altura: 295mm
- Diámetro: 240mm

Código	Capacidad	
CB516	8l.	1



CONTENEDORES ECOLÓGICOS



Código	Módulo	Altura	Capacidad	
CB616K	600	230	22l. (12+5+5)	1
CB616	600	300	29l. (15+7+7)	1

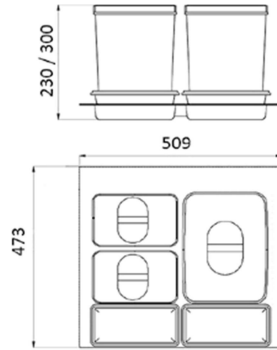

Código	Módulo	Altura	Capacidad	
CB816K	800	230	34l. (12+12+5+5)	1
CB816	800	300	44l. (15+15+7+7)	1

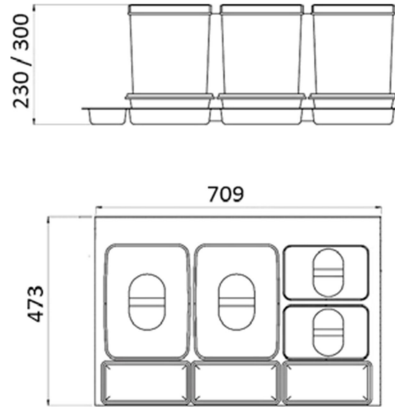

Código	Módulo	Altura	Capacidad	
CB916K	900	230	34l. (12+12+5+5)	1
CB916	900	300	44l. (15+15+7+7)	1

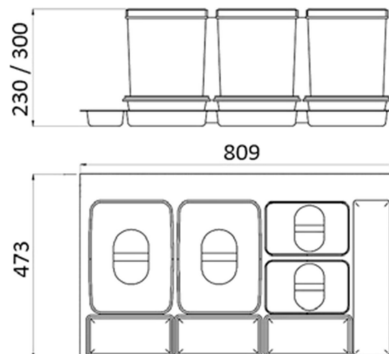



CUBO ECOLÓGICO 11l

Código	Capacidad	
--------	-----------	--

- Para puertas desde 400mm
- Acabado acero inoxidable

CB416	11l.	1
-------	------	---



IZQUIERDA DERECHA

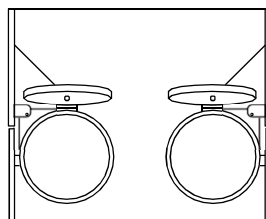

- Se puede instalar tanto a la derecha como a la izquierda

CONTENEDORES ECOLÓGICOS



Código	Capacidad	
CBM134	34l.	1



Código	Capacidad	
CBM226	52l.	1



CONTENEDORES RESIDUOS Grafito

- Incluye guías de cierre suave
- Regulación 3D del frontal



FF300

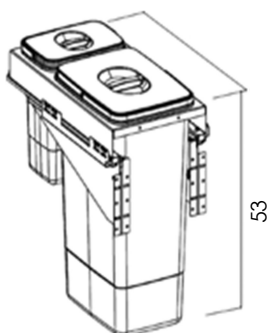

FF400

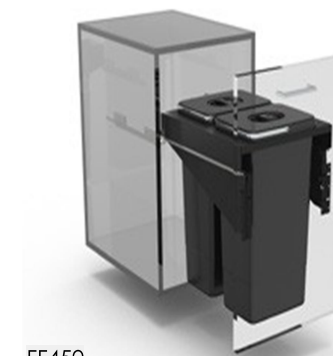
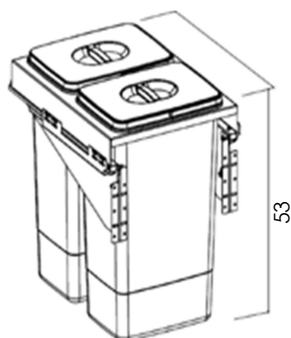

FF450

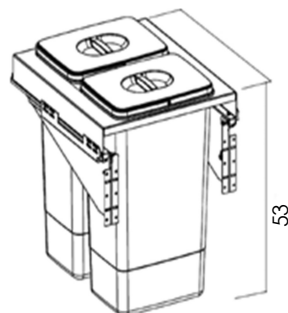

FF600

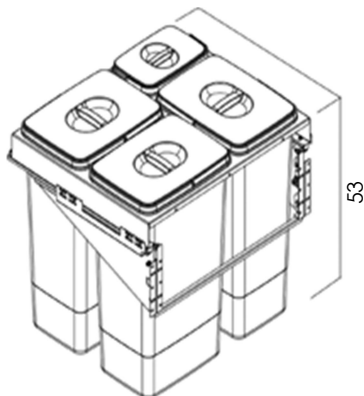

Código	Módulo	Capacidad	
FF300	30	26 + 7l	1
FF400	40	26 + 26l	1
FF450	45	26 + 26l	1
FF600	60	26 + 26 + 26 + 7l	1



PATAS DE MESA



Acabado	Altura 710	Altura 830	Altura 870	
Blanco	KT71B	KT83B	KT87B	4
Negro	KT71N	KT83N	KT87N	4
Gris	KT71A	KT83A	KT87A	4
Cromo brillo	KT71CB	KT83CB	KT87CB	4
Níquel satinado	KT71NS	KT83NS	KT87NS	4
Cromo mate	KT71CM	KT83CM	KT87CM	4

- Regulación de 0 a 30mm
- Diámetro de la pata, 60 mm



- Regulación de 0 a 30mm

Acabado	Altura 710	Altura 870	
Níquel satinado	ST71NS	ST87NS	4
Cromo brillo	ST71CB	ST87CB	4
Gris	ST71A	ST87A	4

PATAS DECORATIVAS



Regulable

Código	Altura	Acabado	
DX101.100	100	Cromo brillo	100
DX101.150	150	Cromo brillo	100



Regulable

Código	Altura	Acabado	
6010.80	80	Plata mate	100
6010.100	100	Plata mate	100
6010.120	120	Plata mate	100
6010.150	150	Plata mate	100
Ajustable			
6010.100R	100	Plata mate	100
6010.150R	150	Plata mate	100



Regulable

Código	Altura	Acabado	
DX102.100	100	Cromo brillo	100
DX102.150	150	Cromo brillo	100



Regulable

Código	Altura	Acabado	
DX103.100	100	Níquel satinado	100
DX103.150	150	Níquel satinado	100



Regulable

Código	Altura	Acabado	
6012.100	100	Plata mate	100



Regulable

Código	Altura	Acabado	
DX104.50	50	Níquel satinado	100

PATAS DECORATIVA Aluminio



Regulable

Acabado	Altura 80	Altura 100	Altura 120	Altura 150	
Plata mate	6010.80	6010.100	6010.120	6010.150	20
Negro mate		6010.100NE		6010.150NE	20
Plata mate (regulable)		6010.100R		6010.150R	20
Negro Mate (regulable)		6010.100RNE		6010.150RNE	20
MEDIDAS 38 X 38 mm					

PATAS HORQUILLA Acero negro

Capacidad de carga 30 kgj Embalaje 20 uds

Código	Altura	Acabado	
HT406N	406	Acero negro	100
HT710N	710	Acero negro	100

Ø 12 Ø 12
2 varillas 3 varillas

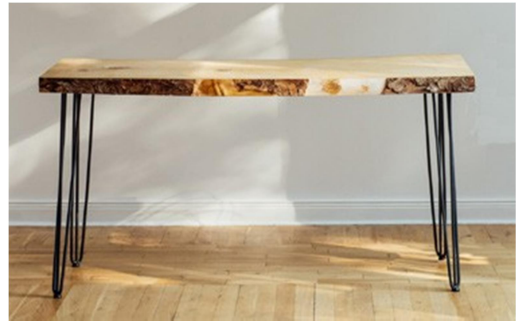

Base con soporte antideslizante.
4 unidades



SOPORTES ESTANTERIA Acero negro

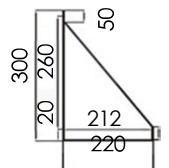
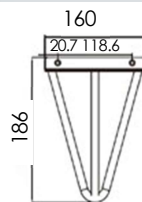
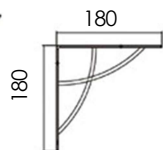

SOPORTES ESTANTERIA

CT1



CT2



CT3

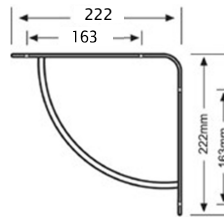
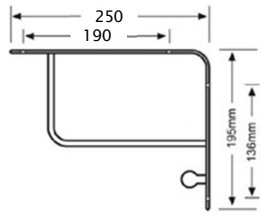
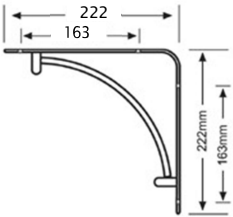

Código	Acabado	
CT1	Niquelado satinado	2
CT2	Niquelado satinado	2
CT3	Niquelado satinado	2

PELICANOS



Código	Acabado	
PS1	Gris	2
PS2	Gris	2
PS3	Gris	2

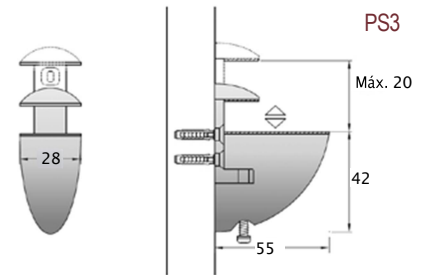
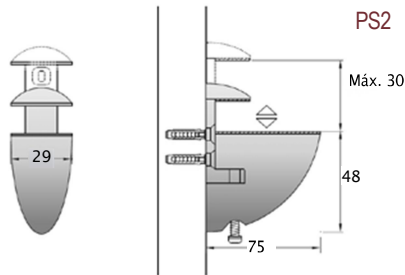
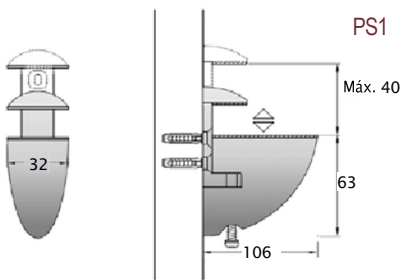

JUEGO COLGADOR OCULTO



Código	
A3	50

- Incluye: 2 colgadores, 1 chapa y 2 tapones blancos
- Capacidad de carga 175 Kg

BISAGRAS 105° CIERRE SUAVE

CLIP-ON

- Ángulo de apertura 105°
- Profundidad de la cazoleta 11'5 mm
- Diámetro cazoleta 35 mm
- Distancia entre tornillos cazoleta 48 mm
- Acabado: Níquel o grafito

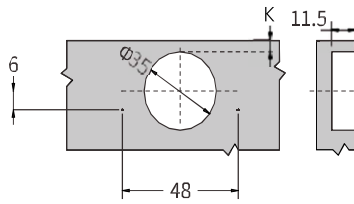

BISAGRA RECTA DE CIERRE SUAVE



Código	Fijación	Acabado	
3601	Tornillo	Níquel	200
3601T10	Tacos 10 mm	Níquel	200
3601GR	Tornillo	Grafito	200
3601T10GR	Tacos 10 mm	Grafito	200

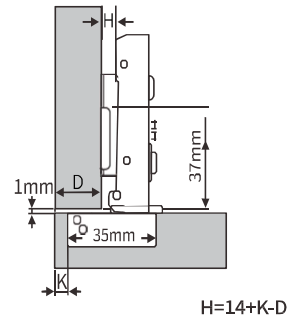
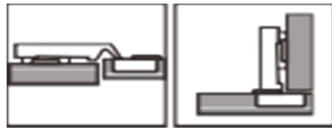

D	H	K	3	4	5	6	7
0			17	18	19	20	21
2			15	16	17	18	19

BISAGRA ACODADA DE CIERRE SUAVE



Código	Fijación	Acabado	
3602	Tornillo	Níquel	200
3602T10	Tacos 10 mm	Níquel	200
3602GR	Tornillo	Grafito	200

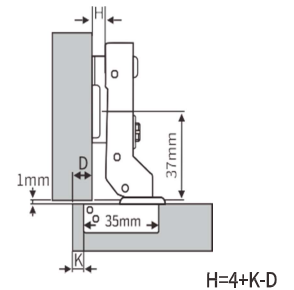
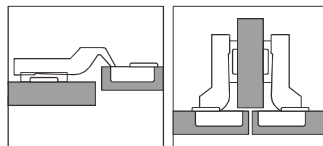

D	H	K	3	4	5	6	7
0			7	8	9	10	11
2			5	6	7	8	9

BISAGRA SÚPER ACODADA DE CIERRE SUAVE



Código	Fijación	Acabado	
3603	Tornillo	Níquel	200
3603T10	Tacos 10 mm	Níquel	200
3603GR	Tornillo	Grafito	200

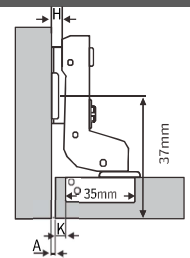

A	K	3	4	5	6	7
0		1	0	-1	-2	-3
2		3	2	1	0	-1

BISAGRA CLIP-ON 30° DE CIERRE SUAVE



Código	Fijación	Acabado	
5303	Tornillo	Níquel	200
5303T10	Tacos 10 mm	Níquel	200

- Ángulo de apertura 30°
- Profundidad de la cazoleta 11'5 mm
- Diámetro cazoleta 35 mm
- Distancia entre tornillos cazoleta 48 mm
- Acabado: Níquel

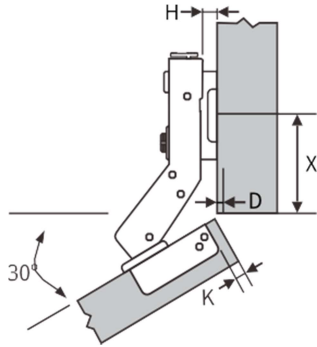
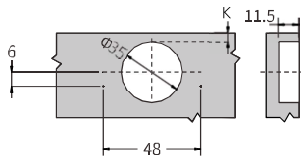

X \ D \ K	4	5	6	7
0	37/3	36/4	35/5	34/6
2	37/1	36/2	35/3	34/4

BISAGRA CLIP-ON 45° DE CIERRE SUAVE



Código	Fijación	Acabado	
5303	Tornillo	Níquel	200
5303T10	Tacos 10 mm	Níquel	200

- Ángulo de apertura 45°
- Profundidad de la cazoleta 11'5 mm
- Diámetro cazoleta 35 mm
- Distancia entre tornillos cazoleta 48 mm
- Acabado: Níquel

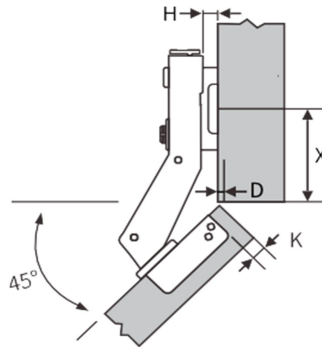
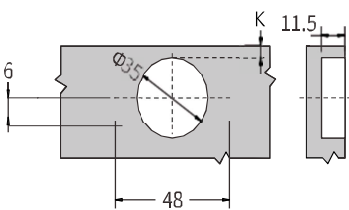

X \ D \ K	4	5	6	7
0	37/3	36/4	35/5	34/6
2	37/1	36/2	35/3	34/4

BISAGRA CLIP-ON 90° DE CIERRE SUAVE



Código	Fijación	Acabado	
5301	Tornillo	Níquel	200
5303T10	Tacos 10 mm	Níquel	200
5301GR	Tornillo	Grafito	200



- Ángulo de apertura 90°
- Profundidad de la cazoleta 11'5 mm
- Diámetro cazoleta 35 mm
- Distancia entre tornillos cazoleta 48 mm
- Acabado: Níquel o grafito

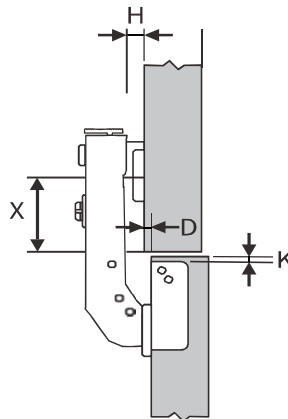
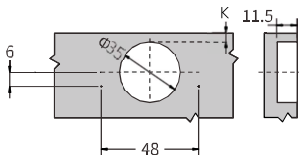

$\begin{matrix} D \\ X \\ H \end{matrix}$ K	4	5
0	$\frac{20}{3}$	$\frac{19}{3}$
2	$\frac{20}{1}$	$\frac{19}{1}$

BISAGRA CLIP-ON 165° DE CIERRE SUAVE



Código	Fijación	Acabado	
4301	Tornillo	Níquel	200
4303T10	Tacos 10 mm	Níquel	200
4301GR	Tornillo	Grafito	200



- Ángulo de apertura 165°
- Profundidad de la cazoleta 11'5 mm
- Diámetro cazoleta 35 mm
- Distancia entre tornillos cazoleta 48 mm
- Acabado: Níquel o grafito

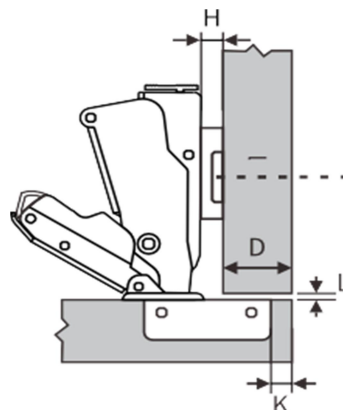
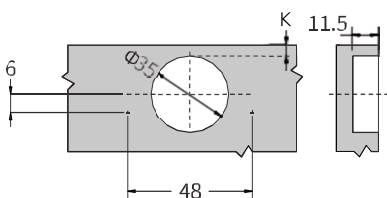

$H=14+K-D$					
$\begin{matrix} D \\ H \end{matrix}$ K	3	4	5	6	7
0	17	18	19	20	21
2	15	16	17	18	19

BISAGRAS 105°

CLIP-ON

- Ángulo de apertura 105°
- Profundidad de la cazoleta 11'5 mm
- Diámetro cazoleta 35 mm
- Distancia entre tornillos cazoleta 48 mm
- Acabado: Níquel o grafito

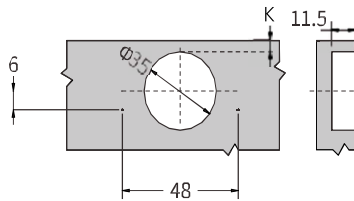

BISAGRA RECTA



Código	Fijación	Acabado	
2301	Tornillo	Níquel	200
2301T10	Tacos 10 mm	Níquel	200
2301GR	Tornillo	Grafito	200

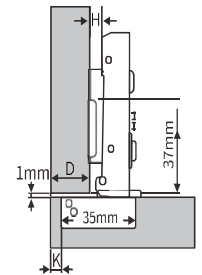

$H=14+K-D$

D	H	K	3	4	5	6	7
0			17	18	19	20	21
2			15	16	17	18	19

BISAGRA ACODADA



Código	Fijación	Acabado	
2302	Tornillo	Níquel	200
2302T10	Tacos 10 mm	Níquel	200

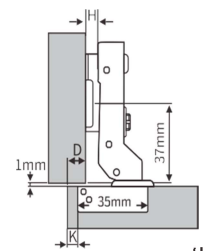
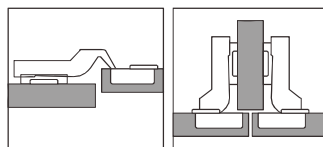

$H=4+K-D$

D	H	K	3	4	5	6	7
0			7	8	9	10	11
2			5	6	7	8	9

BISAGRA SÚPER ACODADA



Código	Fijación	Acabado	
2303	Tornillo	Níquel	200
2303T10	Tacos 10 mm	Níquel	200

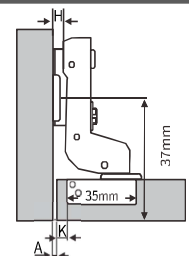

A	H	K	3	4	5	6	7
0			1	0	-1	-2	-3
2			3	2	1	0	-1

BASE CLIP ON 3D

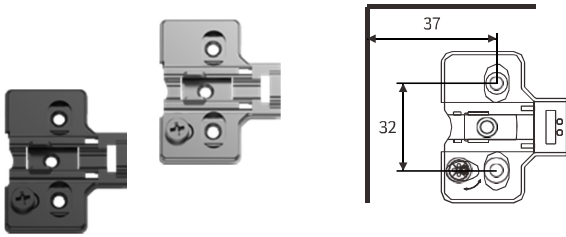

Código	Fijación	Calce	Acabado	
D	Tornillos	H=0	Niquel	400
DT5	Tacos 5 mm	H=0	Niquel	400
DT10	Tacos 10 mm	H=0	Niquel	400
D2	Tornillos	H=2	Niquel	400
D2T5	Tacos 5 mm	H=2	Niquel	400
D2T10	Tacos 10 mm	H=2	Niquel	400
DGR	Tornillos	H=0	Grafito	400
DT5GR	Tacos 5 mm	H=0	Grafito	400
D2GR	Tornillos	H=2	Grafito	400

TAPAS



Código	Acabado	
EC (Cabeza)	Niquel	1000

Código	Acabado	
EB (Cuerpo)	Niquel	2000

PISTONES

ELEVABLES

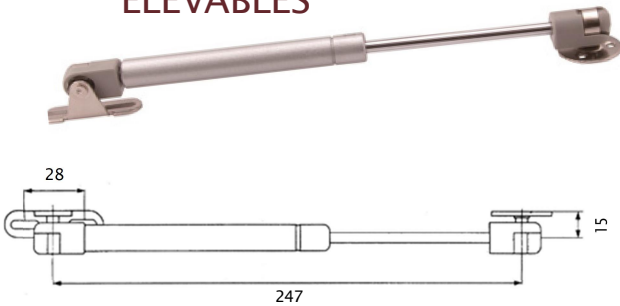

ENGANCHE LATERAL MÓDULO



ADAPTADOR PUERTA MADERA



ADAPTADOR PUERTA ALUMINIO

· Adaptadores incluidos

ABATIBLES

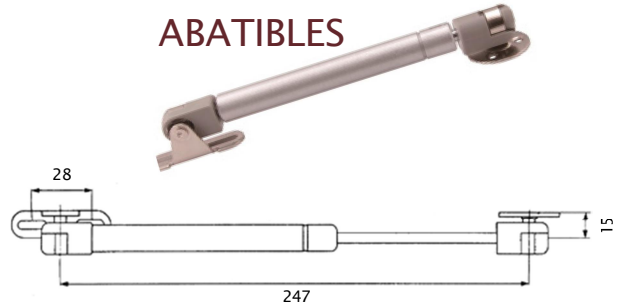

ENGANCHE LATERAL MÓDULO



ADAPTADOR PUERTA MADERA



ADAPTADOR PUERTA ALUMINIO

· Adaptadores incluidos

Código	Fuerza	Tipo	
GS5	5 kg.	Elevable	25
GS6	6 kg.	Elevable	25
GS8	8 kg.	Elevable	25
GS10	10 kg.	Elevable	25
GS12	12 kg.	Elevable	25
GS15	15 kg.	Elevable	25

Código	Fuerza	Tipo	
GS8A	8 kg.	Abatible	25
GS10A	10 kg.	Abatible	25
GS12A	12 kg.	Abatible	25

TUBO OVALADO



Código	
CT40	80 m

SOPORTE CENTRAL Y LATERAL



Código	Tipo	Acabado	
CT41	Lateral	Níquel	250
CT43	Lateral	Plata mate	250
CT42	Central	Níquel	100
CT44	Central	Plata mate	100

PANTALONERO Extraíble y extensible



Código	Módulo	Barras	
CT7	600	6	5
CT8	700	8	5
CT9	800	10	5
CT10	900	12	5

PANTALONERO Extraíble

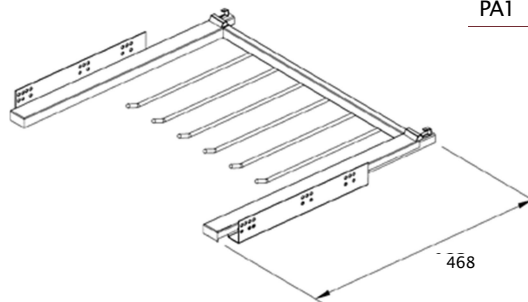

Código	Módulo	
PA1	600	1

PANTALONERO

Embalaje 1 ud

Módulo	60	70	80	90
--------	----	----	----	----

Crafito Ref. PAN60-IG PAN70-IG PAN80-IG PAN90-IG

• Incluye guías de cierre suave

Módulo (W1 - W2)

600	(564-614)
700	(664-714)
800	(764-814)
900	(864-914)

Adaptable al ancho de módulo (extensible +50)

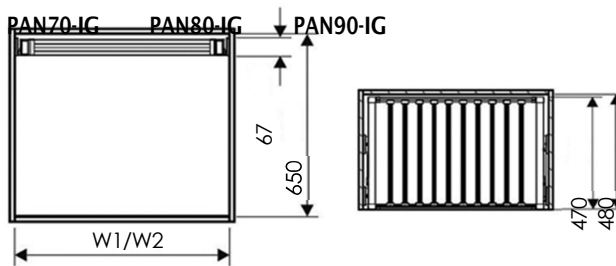

CESTO MULTIUSOS

Embalaje 1 ud

Módul	60	70	80	90
-------	----	----	----	----

Crafito Ref. CES60-IG

Incluye guías de cierre suave

Módulo (W1 - W2)

600	(564-614)
700	(664-714)
800	(764-814)
900	(864-914)

Adaptable al ancho de módulo (extensible +50)

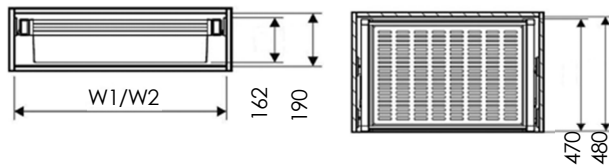

ZAPATERO

Embalaje 1 ud

Módul	60	70	80	90
-------	----	----	----	----

Crafito nnnn ZAP60-IG ZAP70-IG ZAP80-IG ZAP90-IG

• Incluye guías de cierre suave

Módulo (W1 - W2)

600	(564-614)
700	(664-714)
800	(764-814)
900	(864-914)

Adaptable al ancho de módulo (extensible +50)

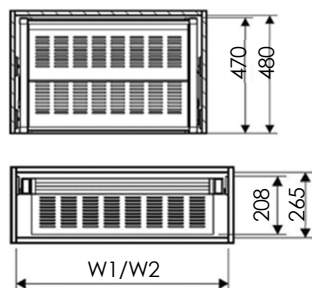

ZAP90



ORGANIZADOR DE ACCESORIOS

Embalaje 1 ud

Módulo	60	70	80	90
--------	----	----	----	----

Grafito Ref. ORG60-IG ORG70-IG ORG80-IG ORG90-IG

- Incluye guías de cierre suave

Módulo (W1 - W2)

600 (564-614)

700 (664-714)

800 (764-814)

900 (864-914)

Adaptable al ancho de módulo (extensible +50)

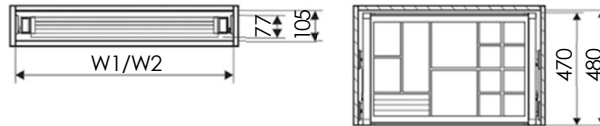

PANTALONERO DOBLE

Embalaje 1 ud

Módulo 70

Crafito Ref. D131-IG

- Incluye guías de cierre suave

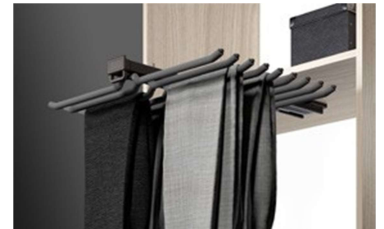
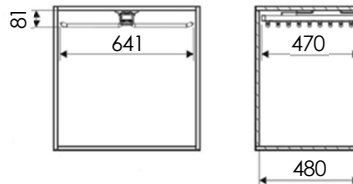

PERCHERO EXTRAIBLE

Embalaje 1 ud

Fondo 470 306

Crafito Ref. D141-IG D142-IG

- Incluye guías de cierre suave

Módulo (D1 - D2)

470 (470-480)

306 (306-320)

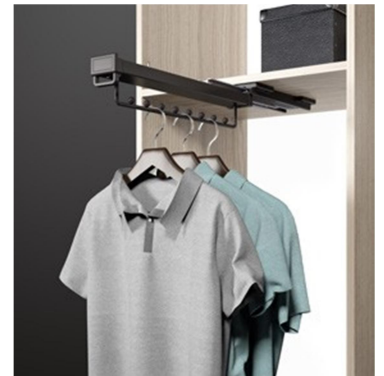
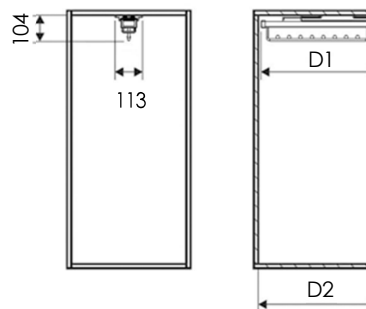

COLGADOR ABATIBLE

Embalaje 6 uds

Módulo 600-700 700-900 900-1200

Crafito Ref. COLG20-IG COLG21-IG COLG22-IG

Aluminio COLG20-AL COLG21-AL COLG22-AL



COLGADORES

COLGADOR 3 posiciones



Código	Agujeros	
CT29	6	4

COLGADOR EXTRAÍBLE

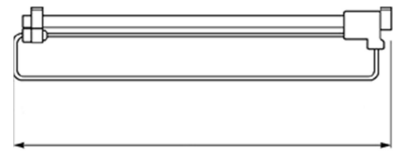

300 / 350 / 400 / 450

COLGADOR ABATIBLE

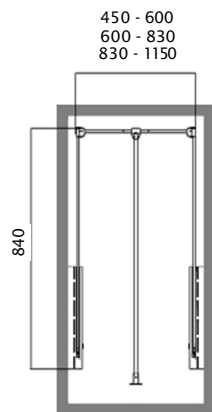

Código	Fondo	
PA30	300	20
PA35	350	20
PA40	400	20
PA45	450	20

Código	Medida	
CT20	450 - 600	6
CT21	600 - 830	6
CT22	830 - 1150	6

ZAPATERO Extensible-extraíble con frontal



Código	Medida	
CT13	400 - 600	2
CT15	600 - 1000	2

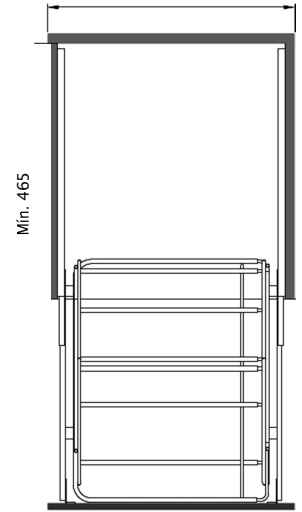

ZAPATERO Extensible



Código	Medida	
CT11	450 - 700	10
CT12	700 - 1100	10

PANTALONERO 9 o 11 perchas

PANTALONERO 20 perchas



· Con anillas antideslizantes

Código	Perchas	
CT5	9	2
CT6	11	2



· Con anillas antideslizantes

Código	Perchas	
CT4	20	2

FREGADERO INOX Bajo encimera



MEDIDAS

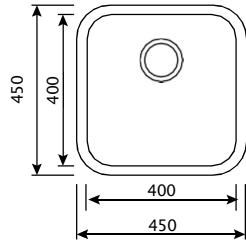
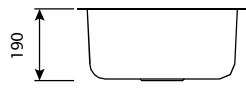

INSTALACIÓN

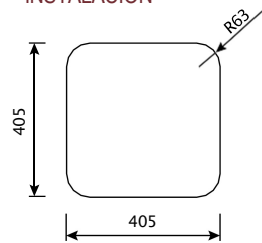

Código	Material	Espesor	
SU4545	AISI304	0'8 mm	5



MEDIDAS

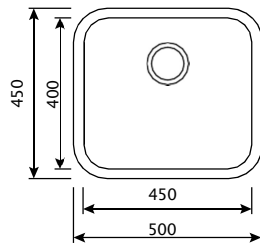

INSTALACIÓN

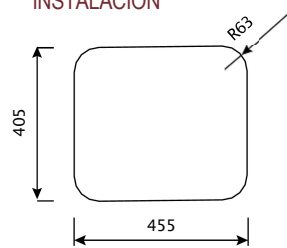

Código	Material	Espesor	
SU5045	AISI304	0'8 mm	5



MEDIDAS

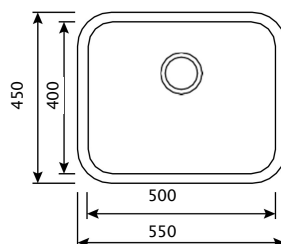

INSTALACIÓN

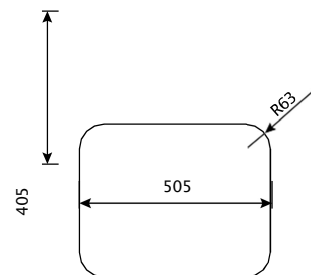

Código	Material	Espesor	
SU5545	AISI304	0'8 mm	5

FREGADERO INOX Bajo encimera



MEDIDAS

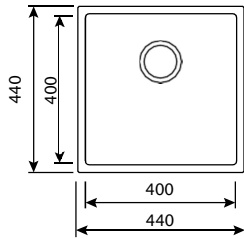
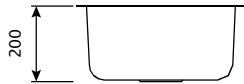

INSTALACIÓN

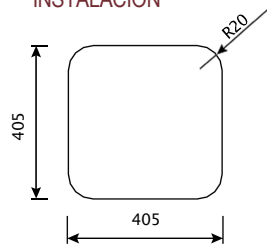

Código	Material	Espesor	
SU4444	AISI304	0'8 mm	5



MEDIDAS

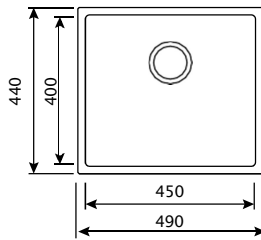

INSTALACIÓN

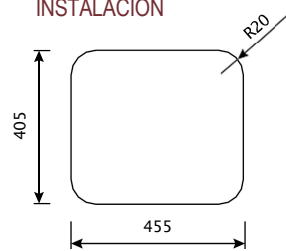

Código	Material	Espesor	
SU4944	AISI304	0'8 mm	5



MEDIDAS

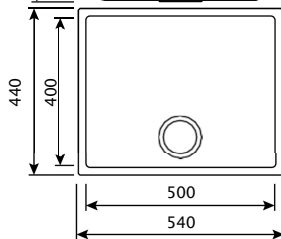

INSTALACIÓN

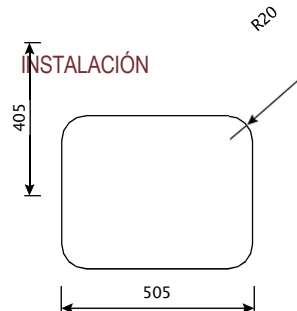

Código	Material	Espesor	
SU5444	AISI304	0'8 mm	5

FREGADERO INOX Encastrable



MEDIDAS

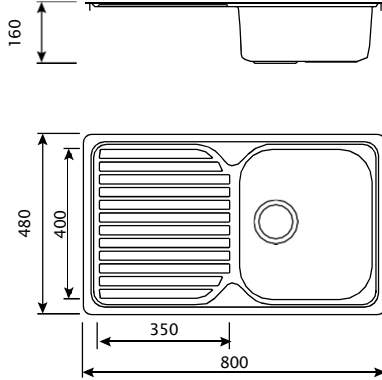

Código	Material	Espesor	
TE8048	AISI304	0'6 mm	5

INSTALACIÓN

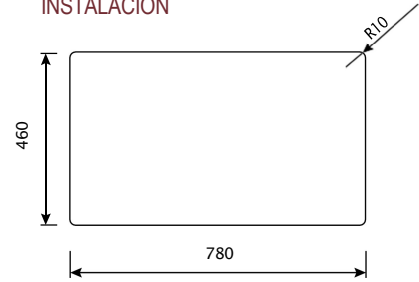

· Sin agujero

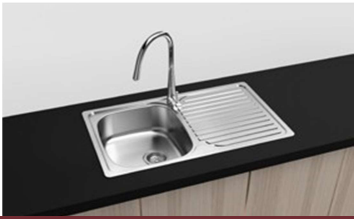

MEDIDAS

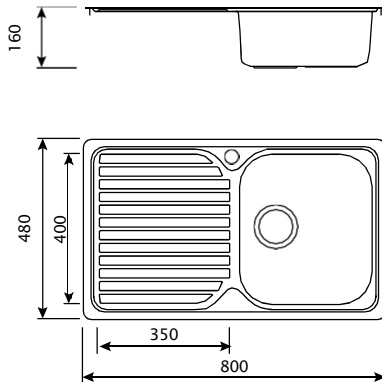

Código	Material	Espesor	
TE8048L	AISI304	0'6 mm	5

INSTALACIÓN

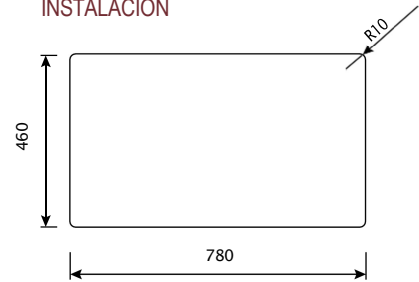

· Con agujero para grifo
(Escurreidor en la izquierda)



MEDIDAS

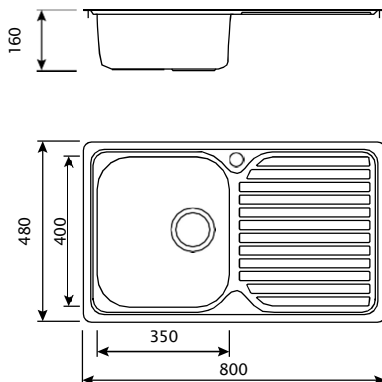

Código	Material	Espesor	
TE8048R	AISI304	0'6 mm	5

INSTALACIÓN

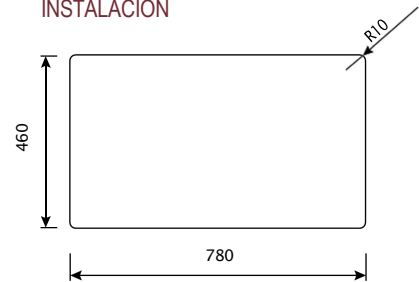

· Con agujero para grifo
(Escurreidor en la derecha)

FREGADERO INOX Encastrable



MEDIDAS

Código	Material	Espesor	
SE8444	AISI304	0'6 mm	5



INSTALACIÓN

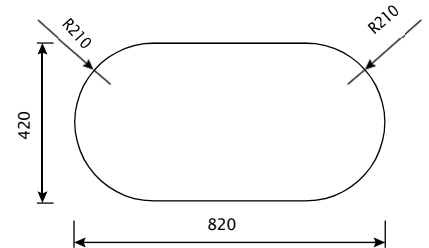
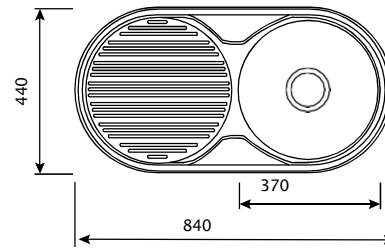

· Sin agujero



MEDIDAS

Código	Material	Espesor	
SE8444L	AISI304	0'6 mm	5



INSTALACIÓN

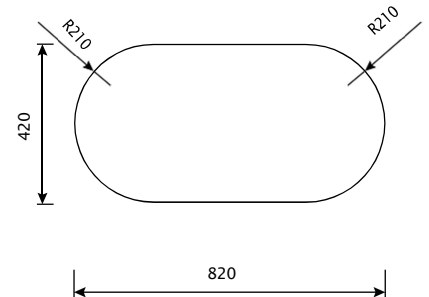
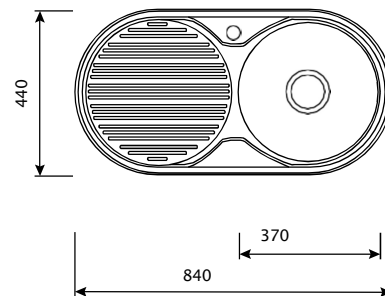

· Con agujero para grifo (Escurredor en la izquierda)



MEDIDAS

Código	Material	Espesor	
SE8444R	AISI304	0'6 mm	5



INSTALACIÓN

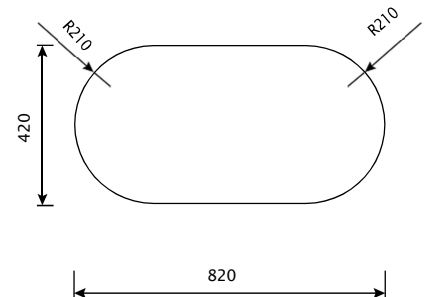
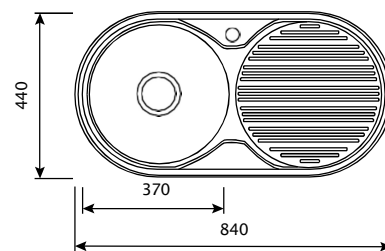

· Con agujero para grifo (Escurredor en la derecha)

FREGADERO INOX Encastrable



MEDIDAS



Código	Material	Espesor	
DE8444	AISI304	0'6 mm	5

INSTALACIÓN

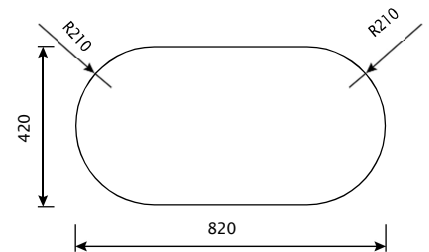
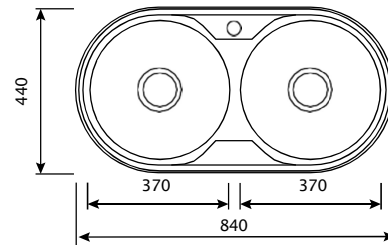

· Con agujero para grifo



MEDIDAS



Código	Material	Espesor	
DE8250	AISI304	0'6 mm	5

INSTALACIÓN

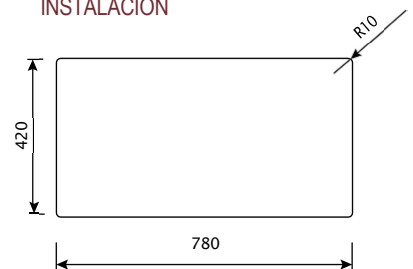
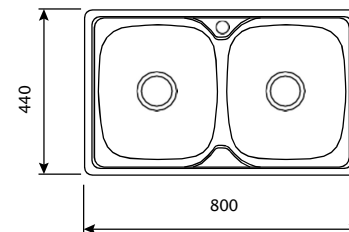

· Con agujero para grifo



MEDIDAS



Código	Material	Espesor	
SE4848	AISI304	0'6 mm	5

INSTALACIÓN

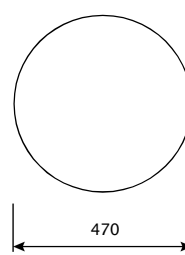
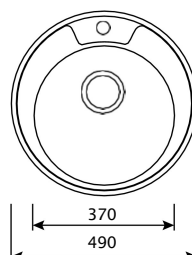

· Con agujero para grifo

FREGADERO INOX Encastrable



· Sin agujero

Código	Material	Espesor	
DE10048	AISI304	0'6 mm	5

MEDIDAS

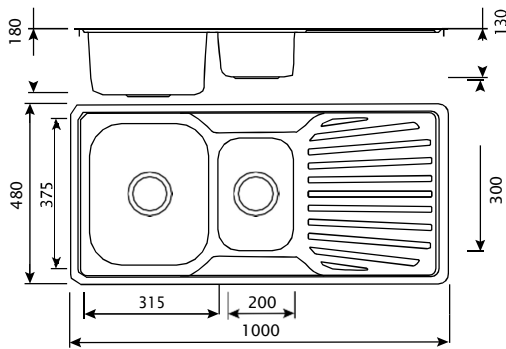

INSTALACIÓN

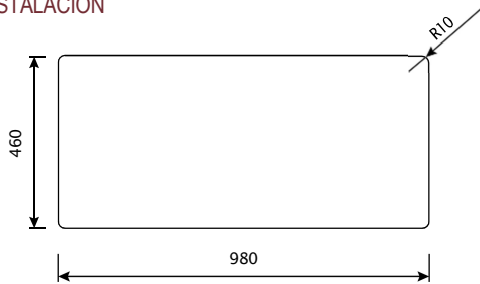

· Sin agujero

Código	Material	Espesor	
DE11848	AISI304	0'6 mm	5

MEDIDAS

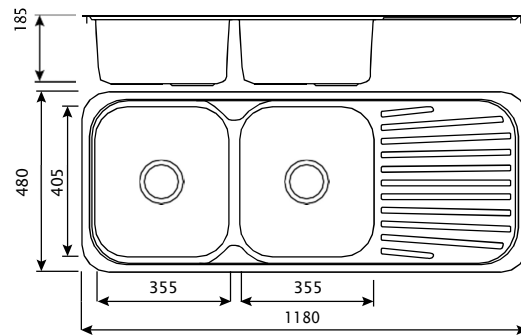

INSTALACIÓN

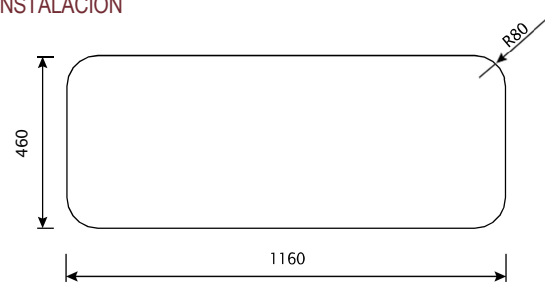

FREGADERO INOX Encastrable



Código

8



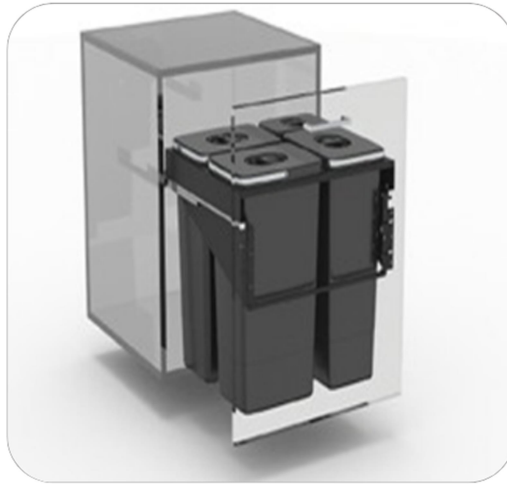

FERRETERIA COLLBLANCH. S.L.

FERRETERIA PER A FUSTERIA, SERRALLERIA I DECORACIÓ

Carrer Mas, 5, L'Hospitalet de Llobregat 08903 Barcelona

+34 93 449 73 20

info@ferreteriacollblanch.es

@ferreteriacollblanch